

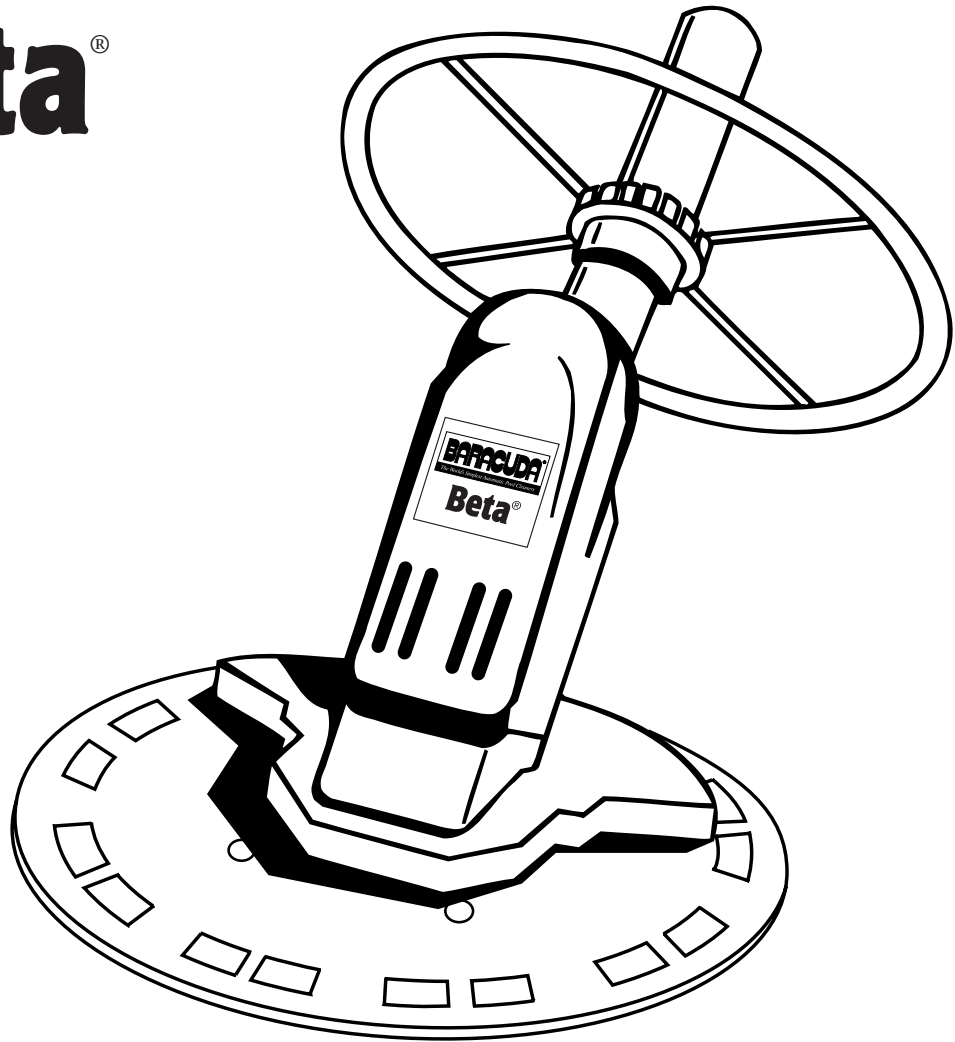

# ZODIAC

## Beta<sup>®</sup>

### OWNER'S MANUAL



**The following parts are included with your Beta (Model# W03398):**

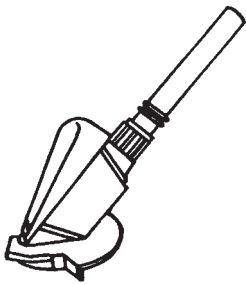

(1) Cleaner Head with Footpad and Apron

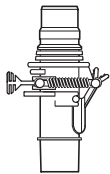

(1) FlowKeeper™ Valve

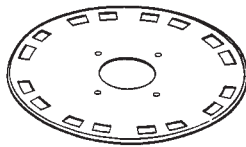

(1) Disc

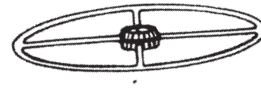

(1) Wheel Deflector



(1) 45 Degree Elbow



(1) Pool Pulse™



(11) Hose Lengths

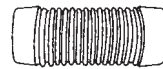

(1) 4 1/2" Connector



(1) Aboveground Valve Cuff



**THANK YOU FOR PURCHASING BETA®.**  
**YOUR BETA HAS BEEN DESIGNED AND MANUFACTURED TO BE EASILY  
INSTALLED AND TO PROVIDE YEARS OF LOW MAINTENANCE OPERATION.**  
**PRIOR TO INSTALLING YOUR NEW BETA, PLEASE DO THE FOLLOWING:**

- 1) Complete and return the warranty card.
- 2) Record your purchase information on the spaces provided below.
- 3) Attach your invoice (or a copy) to this page.

These actions will insure prompt warranty service, should it be required. Simply present your owner's manual, along with the invoice at any of our authorized warranty centers nationwide.

**RECORD YOUR BETA POOL CLEANER DATA HERE:**

Date of Purchase \_\_\_\_\_

Purchased From \_\_\_\_\_

City \_\_\_\_\_ State \_\_\_\_\_ Zip Code \_\_\_\_\_

Serial Number: \_\_\_\_\_ (serial number located on underside of machine head)

**BETA LIMITED WARRANTY**

This BETA® was carefully inspected before shipment from our warehouse. Upon unpacking, if any part proves defective or missing, please notify Zodiac Pool Care, Inc. immediately. Please consult owner's manual for complete instructions on the installation and operation of your BETA®.

ZODIAC POOL CARE, INC. WARRANTS THE BETA® POOL CLEANER AGAINST ALL MANUFACTURING DEFECTS AND ALL WEAR AND TEAR FOR THE FIRST TWO (2) YEARS INCLUDING THE HOSES. ALL WARRANTIES ARE EFFECTIVE FROM THE DATE OF PURCHASE.

Should this product prove defective in workmanship, materials or wear during the applicable warranty period, the consumer's sole and exclusive remedy shall be such repair or replacement of the product as provided below.

**THIS LIMITED WARRANTY EXCLUDES THE FOLLOWING:**

1. Discoloration of the BETA® pool cleaner. This is caused by reaction to ultraviolet rays and the chemicals used in the pool water. Discoloration does not affect the operating ability of the BETA®. Therefore, this Limited Warranty does not cover the replacement of discolored parts.
2. Damage to or malfunction of the unit resulting from excess chlorination or improper water chemistry balance.
3. Replacement of parts which fail or become defective as a result of improper installation, negligence, misuse, abuse or tampering by unauthorized repair personnel.
4. Age, pool water imbalance, and improper installation can cause vinyl pool liners to become brittle or unduly wrinkled. Corrosion of the supporting walls and/or irregularities in the pool base may also cause liner failure. The use of this product in such an environment is at the pool owner's risk. Therefore, the pool owner hereby releases the manufacturer from any and all claims for damage where these conditions exist.
5. The BETA® is designed for use in aboveground pools only. If unit is used in any other application, the pool owner hereby releases the manufacturer from any and all claims. This misuse will void all warranty on the unit.

**THE LIMITED WARRANTY PROVIDED HEREIN IS THE SOLE AND EXCLUSIVE WRITTEN WARRANTY WITH RESPECT TO THE BETA® POOL CLEANER. ALL IMPLIED WARRANTIES IMPOSED BY APPLICABLE LAW, INCLUDING ANY IMPLIED WARRANTY OF MERCHANTABILITY OR FITNESS FOR A PARTICULAR PURPOSE, WITH RESPECT TO EACH COMPONENT OF THE BETA® ARE LIMITED TO THE DURATION OF THE EXPRESS LIMITED WARRANTY WITH RESPECT TO SUCH COMPONENT. SOME STATES DO NOT ALLOW LIMITATIONS ON HOW LONG AN IMPLIED WARRANTY LASTS, SO THE ABOVE LIMITATION MAY NOT APPLY TO YOU.**

In no event shall ZODIAC POOL CARE, INC. be liable in contract or in tort, or under any other legal theory, for lost profits or revenues, loss of use or similar economic loss, or for indirect, special, incidental, consequential or similar damages, even if it has been advised of the possibility of such claim. Some states do not allow the exclusion or limitation of incidental or consequential damages, so the above limitation or exclusion may not apply to you.

No claim under this Limited Warranty will be recognized unless the registration card, included in your box, is completed and returned within fifteen (15) days of the purchase date. Only the original purchaser may submit a claim under this Limited Warranty. Purchaser's claims against ZODIAC POOL CARE, INC., shall be limited to those claims which may be asserted under the Limited Warranty relating to any defect, malfunction or wear of the BETA®.

To obtain warranty replacements or repair, call (888) 786-7797 for authorization. When submitting a claim, always supply serial number, evidence of purchase date, retailer and a brief description of the problems/defects encountered. ZODIAC POOL CARE, INC. reserves the right to repair or replace all defective or worn parts covered by this Limited Warranty and return same to purchaser, freight collect.

ZODIAC POOL CARE, INC. assumes no responsibility for any warranties or representations made by other individuals or businesses beyond the express terms contained in this Limited Warranty.

This warranty gives you specific legal rights, and you may also have other rights which vary from state to state

**IMPORTANT: FOR VINYL LINER POOL OWNERS**

Vinyl liners are subject to deterioration or damage due to age, the effect of chemicals, corrosion or failure of the supporting walls; as well as improper installation, maintenance or cleaning of the supporting walls or base.

Before installing the Beta, examine the interior of your pool carefully. If your vinyl liner is brittle or has stones, wrinkles, roots or metal corrosion in contact with the underside of the liner, or has damage to the base material or supporting walls, do not install the Beta before having a qualified professional perform the necessary repairs.

**Zodiac Pool Care, Inc. will not be responsible for liner damage caused by (1) a Beta cleaner which is out of warranty or in disrepair, or (2) a Beta cleaner used in a pool having a aged or deteriorated liner. YOU ARE RESPONSIBLE FOR LINER DAMAGE IF YOU USE THE BETA UNDER CONDITION (1) OR (2).**

For sale and use in the United States, Canada, and Mexico only. This pool cleaner is not warranted or guaranteed outside of the United States, Canada, or Mexico.

This pool cleaner is covered by one or more of the following Canadian and U.S. patents and Canadian registered design:

U.S. patent nos. 4351077, 4642833, 4742593, 4982754 and 5315728. Canadian patent nos. 1254105, 2181896 and 1256262. Canadian rd. no. 64787.



# ZODIAC

## ABOVEGROUND AUTOMATIC POOL CLEANER INSTALLATION GUIDE

Pool Preparation .....	2
Slotted Disc Installation.....	3
Wheel Deflector Installation .....	3
Hose Assembly.....	4
Removing Air From Hose.....	4
Installation .....	5
Achieving Proper Flow .....	6
Troubleshooting.....	7
Accessories .....	8

### HOW YOUR ZODIAC AUTOMATIC POOL CLEANER WORKS

- Your pool pump pulls water from the skimmer through a strainer basket, then pushes the water through the filter system and back into the pool through the return inlets.
- The Zodiac Automatic Pool Cleaner connects to the skimmer or dedicated vacuum line with the hose sections provided. Water flows through the diaphragm of the cleaner at a rate of 14 to 19 gallons per minute.
- Diverting or re-directing the return inlets downward breaks up the circulation pattern of water within the pool. This allows random cleaning around the pool.
- Most common problems can be eliminated, by reading through the entire manual before installing your new Zodiac Automatic Pool Cleaner.

### POOL COMPONENTS

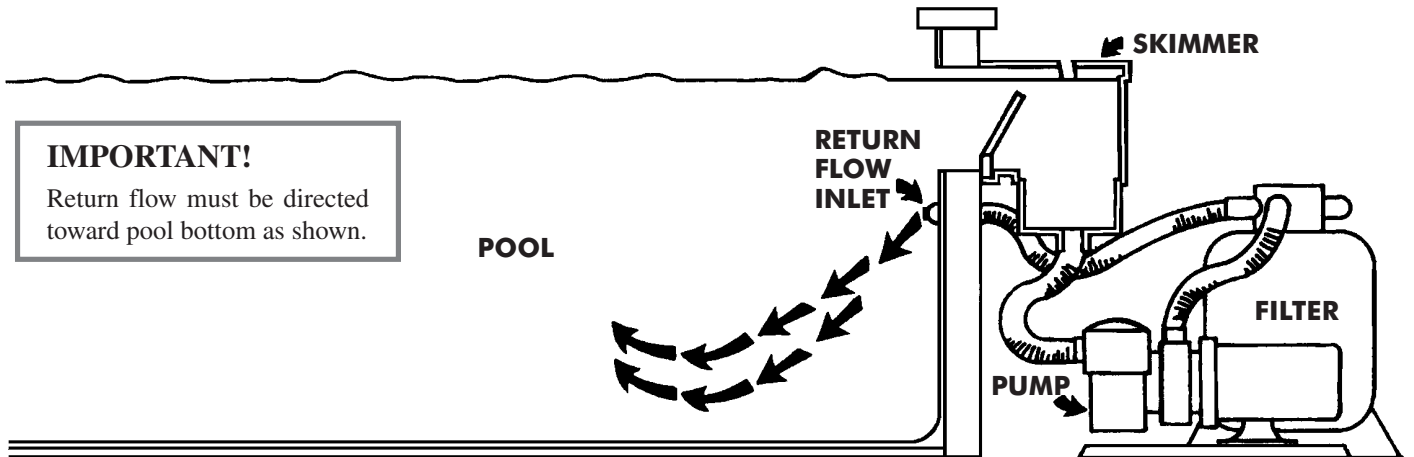

- Please become familiar with the components of your pool shown.
- All diagrams are provided for reference of terminology used throughout this manual. Your pool may vary.



Thank you for purchasing this Automatic Pool Cleaner from Zodiac. Prior to installing your pool cleaner, review the parts and warranty information and insure that all parts shown are included with your unit.

Although the appearance of your model Zodiac Pool Cleaner may differ slightly from some drawings shown in this installation guide, installation steps remain the same.

## STEP 1 - POOL PREPARATION

- Before installing the Zodiac Automatic Pool Cleaner, examine the interior of your pool carefully. If your vinyl liner is brittle or has stones, wrinkles, roots or metal corrosion in contact with the underside of the liner, or has damage to the base material or supporting walls, do not install the pool cleaner before having a qualified professional perform the necessary repairs.
- Manually vacuum the pool. This eliminates unnecessary adjustment later.
- Clean the pool filter and empty the skimmer and pump strainer baskets. Filter pressure rises as debris is cleaned from the water, thus reducing flow.
- Divert the pool return inlets downward - (IMPORTANT!). Your Zodiac Automatic Pool Cleaner must move randomly throughout the pool. Water circulating at the surface will influence the hose and limit coverage.
  - To adjust the return inlet, loosen the lock ring and redirect the eyeball downward, then retighten the lock ring. If the eyeball is difficult to adjust, insert a screwdriver inside the eyeball and gently adjust downward.
  - If the return inlets cannot be pointed downward, then you **MUST** install Zodiac return line diverters. They are available through your Zodiac dealer.

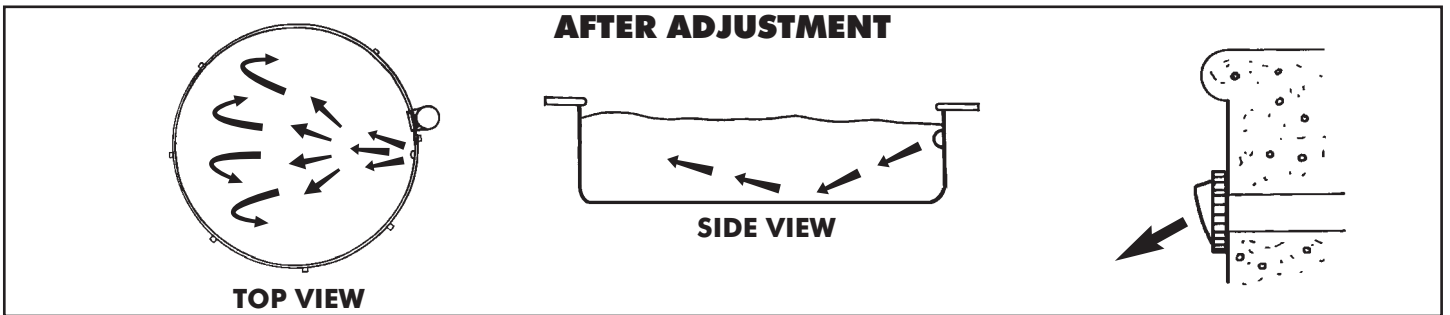
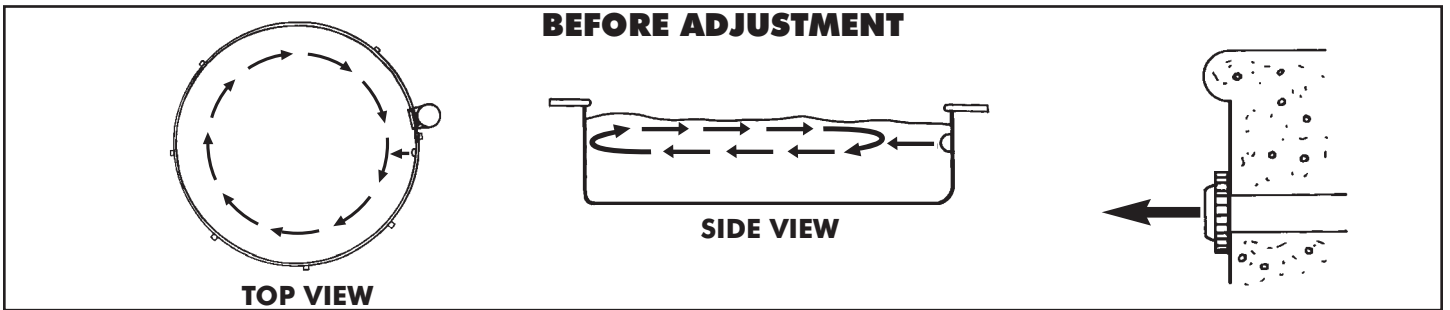

### FOR POOLS WITH RETURN INLET DIRECTIONAL FITTINGS

Replace the directional eyeball with Zodiac retrofit eyeball return line diverter and reinstall eyeball retaining ring.

Part #W90153 for 1½" return lines

Part #W90155 for 2" return lines

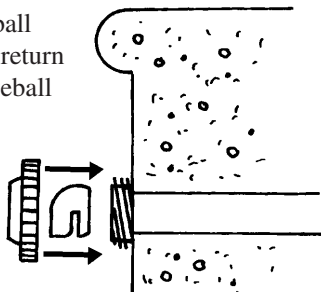

### IF UNABLE TO ADJUST RETURN INLETS OR FOR POOLS WITHOUT RETURN INLET DIRECTIONAL FITTINGS

Use Zodiac universal return line diverter (Part #W24100). Pinch wires together and insert fully into return inlet.

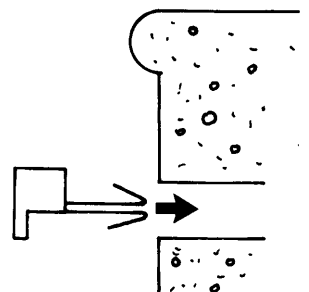

## STEP 2 - SLOTTED DISC INSTALLATION

Slide the slotted disc over the foot pad with the word "TOP" facing upward. Insure the disc fits properly in the grooves provided and rotates freely on the foot pad.

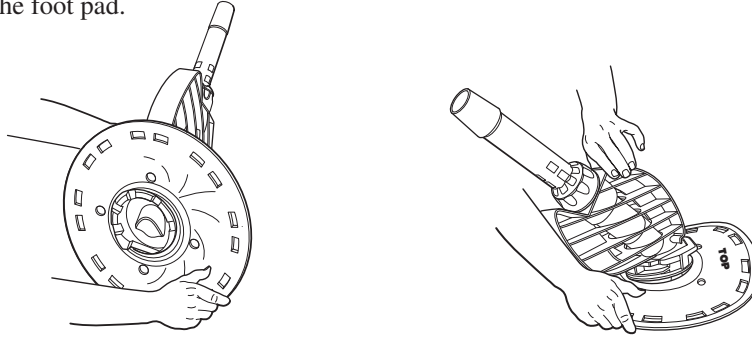

## STEP 3 - WHEEL DEFLECTOR INSTALLATION

Zodiac Pool Cleaners require various wheel deflector locations depending on the model. Follow the instructions below for your specific model. (Model number is stated on the manual cover.)

### MODEL# W01099

Slide the wheel deflector onto the cuff of the first hose section that connects to the cleaner head.

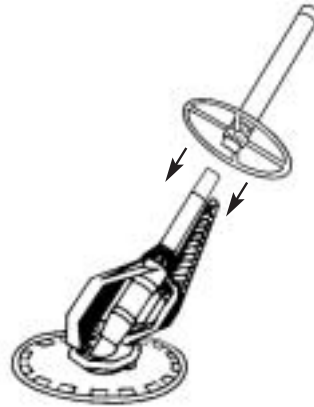

### MODEL# W01698

Slide wheel deflector onto the cassette swivel and over the wheel adapter.

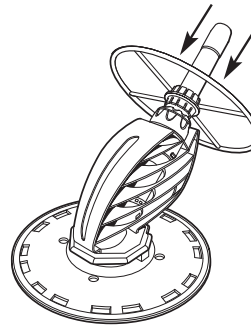

### MODEL# W04598 and W03398

Slide the wheel deflector over the outer extension pipe and secure between the two lowest pipe ridges.

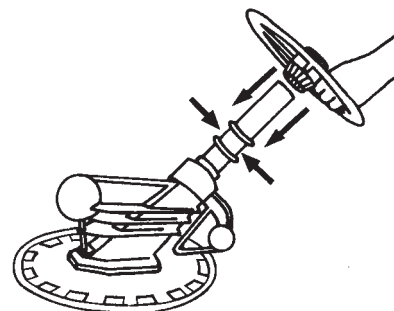

# STEP 4 - HOSE ASSEMBLY

## FOR CENTER INSTALLATIONS

Use enough hose sections to reach the farthest point in the pool, plus two (2) sections.

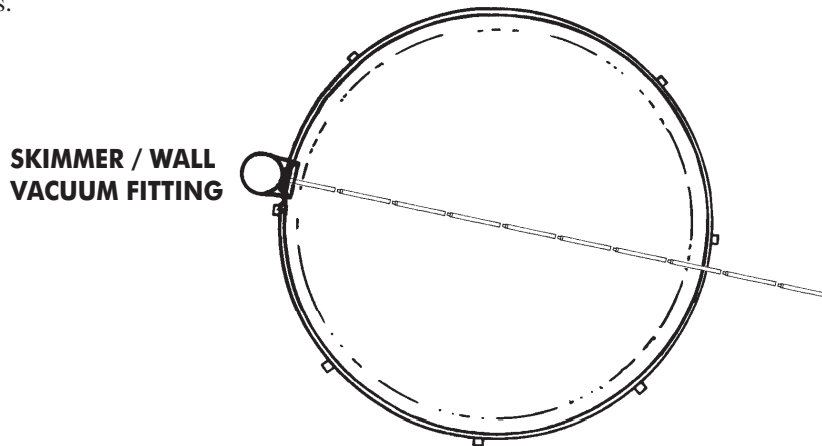

## FOR CORNER OR END INSTALLATIONS

Use enough hose sections to reach the farthest point in the pool, plus one (1) section.

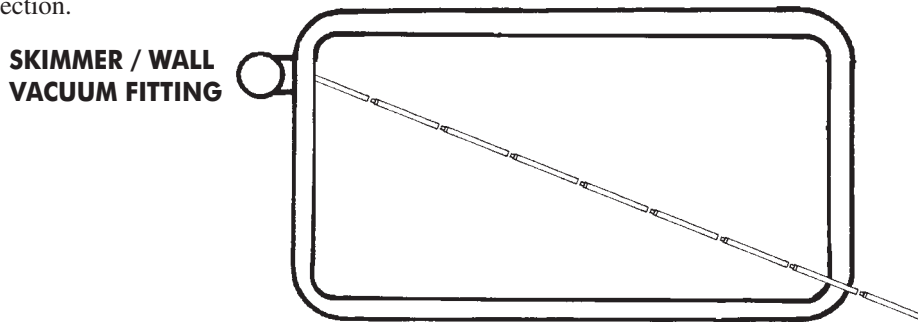

**Note:** You may not need to use all or you may need more hose sections, depending upon your pool size.

# STEP 5 - REMOVING AIR FROM HOSE

- Submerge the pool cleaner head. When bubbles stop coming from the extension pipe, attach the cleaner head to the female end of the hose.
- Turn on the filtration system.
- Fill the hose with water by placing the end over a return inlet.

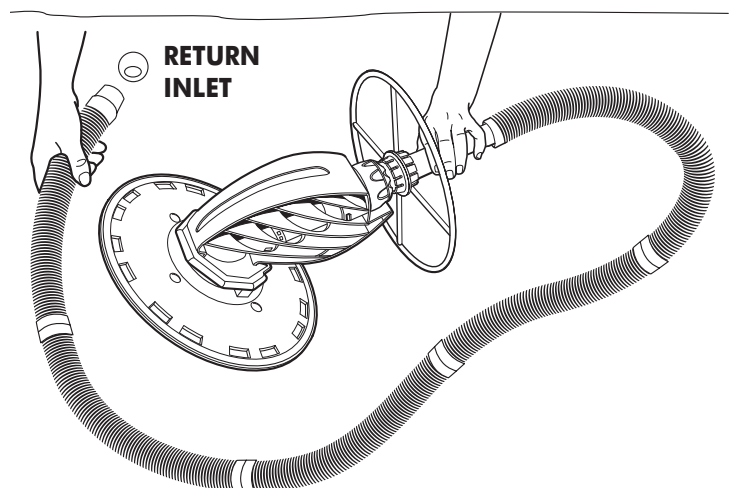
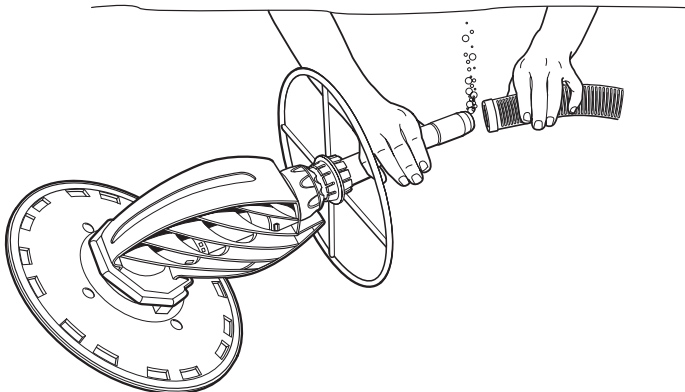

# STEP 6 - INSTALLATION

## FLOWKEEPER VALVE

The Flowkeeper Valve **MUST BE** used on all installations. The pool pump provides more gallon per minute flow than your pool cleaner requires. The Flowkeeper provides a way to regulate the flow with a by-pass so the pool pump and the pool cleaner run properly.

Skimming action is maintained through a bypass throat in the valve. As the filter collects debris, the valve automatically maintains the correct flow to the cleaner. The Flowkeeper Valve comes preset at the setting required for your cleaner. There are a total of three setting options. The lower the setting number, the lower the flow to the cleaner head. Should readjustment become necessary, pull the adjustment handle to raise or lower the setting. The red tab on the valve can be used to keep the bypass open, which in most cases, will cause the cleaner to stop.

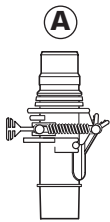
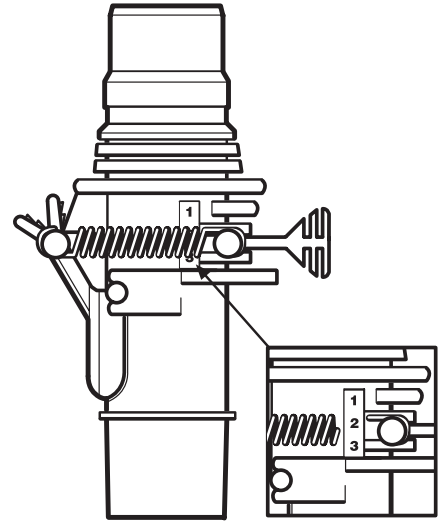

(1) Flowkeeper Valve

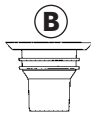

(1) Valve Cuff

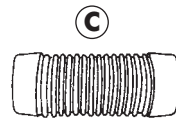

(1) 4 1/2" Connector



(1) 45° Elbow

- Using the parts shown, choose a fitting combination best suited for your pool from figures A or B and install. You may have parts left over.

### FIGURE A Skimmer Installation

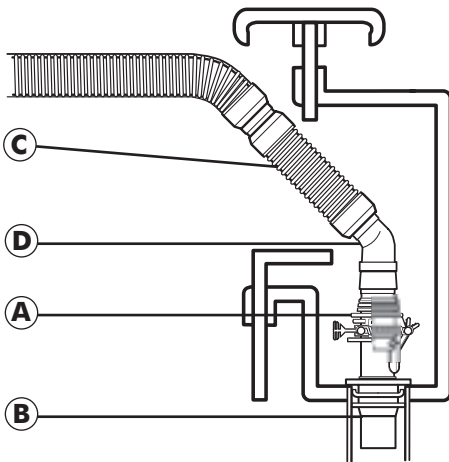

### FIGURE B Vacuum Line Installation

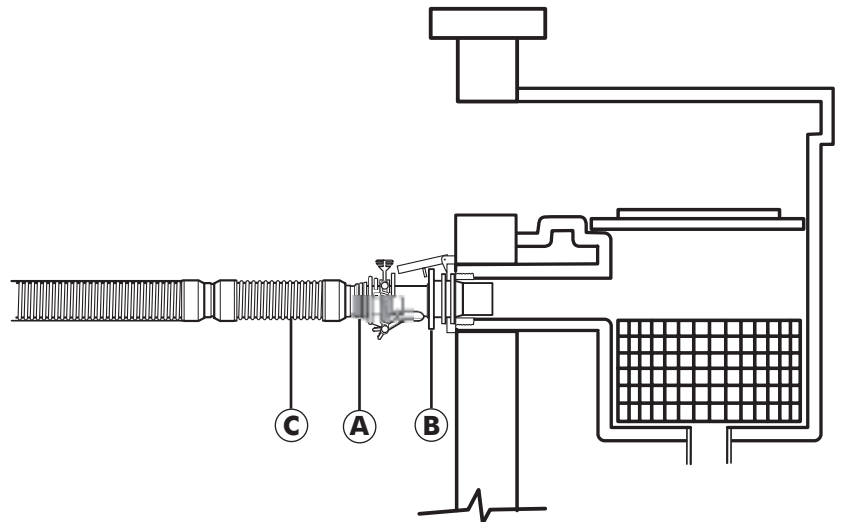

**Important:** To help prevent suction entrapment accidents, wall vacuum fittings should have a safety vac lock installed. Contact your builder or retail pool professional for details.

## STEP 7 - ACHIEVING PROPER FLOW

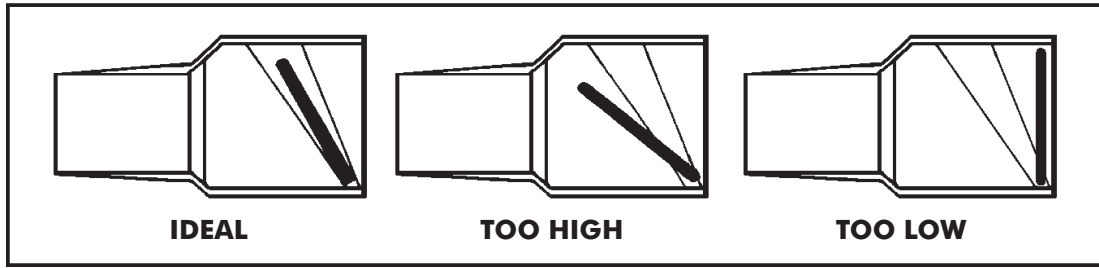

### POOL PULSE®

The Pool Pulse is a flow meter that measures the volume of water flowing through your Zodiac cleaner. It must be used to properly set the flow and can be used as a diagnostic tool when the cleaner isn't running properly.

- Remove the cleaner head.
- Attach the Pool Pulse® to the hose and keep it under water as shown in Figure 1.
- Turn on the filtration system.
- Insure the Pool Pulse is in the ideal range when viewed from the side.
- Keeping the hose under water, remove the Pool Pulse.
- Submerge the cleaner head, and when the bubbles stop coming from the extension pipe, attach the hose end.

Your installation is now complete.

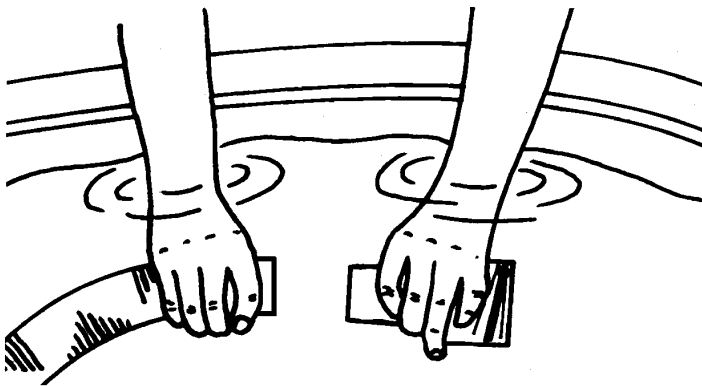

Figure 1

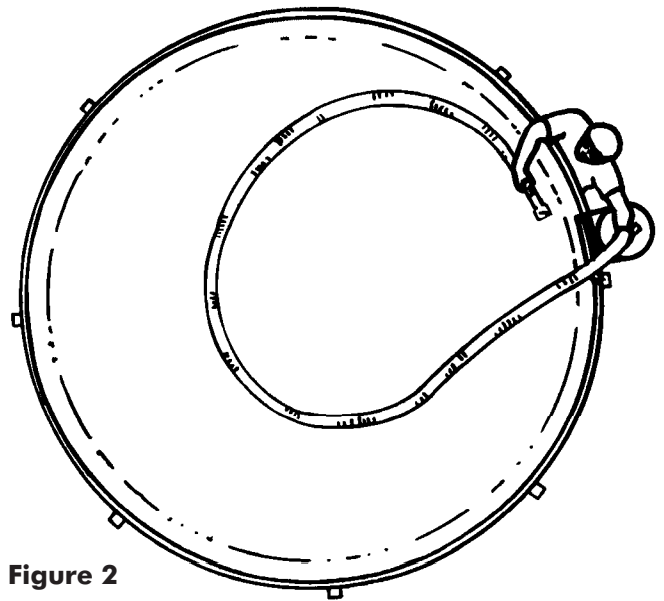

Figure 2

**If the flow is in the low range,** review the installation procedures. A dirty pool filter or clogged basket is usually the main cause of low flow. Other types of hydraulic problems may require a professional pool repairman. If your pool has multiple skimmers and flow is in the low range, close the skimmer the cleaner is not attached to.

**If the flow is in the high range,** review the installation procedures. Lower Flowkeeper setting to #1.

**Note:** If the automatic pool cleaner is climbing the walls excessively, that is an indication that the flow is too high. Review the installation procedures and insure the Flowkeeper is set at setting #1. For additional assistance contact Technical Service 1-888-786-7797.

# TROUBLESHOOTING

## PROBLEM



## SOLUTION

Cleaner stops & starts	Check diaphragm for blockage or damage. Use Pool Pulse® to determine proper flow. Check hoses for leaks.
Cleaner is patterning	Add return diverters or divert return inlets downward. Lay hose in a straight line in the sun to relax memory. Confirm proper hose length - add 1 to 2 hose sections.
Cleaner isn't covering opposite end of pool	Add return diverters or divert return inlets downward. Use flow to move cleaner to opposite end.
Cleaner stuck at steps	Utilize return flow to move cleaner. Confirm proper hose length. Adjust flow to cleaner. Install large wheel deflector.
Cleaner stuck on ladder	Use Pool Pulse to insure proper flow. Remove ladder if possible. Install large wheel deflector.
Cleaner flips over	Use Pool Pulse to insure proper flow. Contact Tech Services for local warranty station.
Cleaner climbs walls excessively	Use Pool Pulse to insure proper flow. Insure Flowkeeper is on setting #1. Reduce flow to cleaner head. Contact Tech Services.
Cleaner doesn't move	Use Pool Pulse to insure proper flow. Clean baskets & filter. Check diaphragm for damage. Check hose sections for leaks by lifting each section above water.
Solar blanket installation	Coverage will be limited due to blanket.

**NOTE:** In cold water of 60° or less, water flow through the cleaner must be increased to compensate for the reduced flexibility of the hose and diaphragm.

**IF ASSISTANCE IS REQUIRED, PLEASE CALL TECH SERVICES AT 1-888-786-7797**

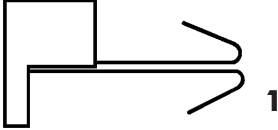
# ZODIAC ACCESSORIES

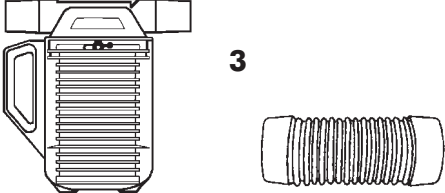
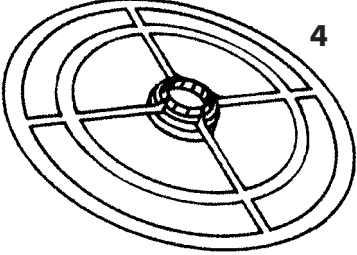
PART ILLUSTRATION	PART NO.	DESCRIPTION
	<p>1. W24100</p>	<p><b>Return Line Diverter</b> Use when no other return inlet directional fittings exist.</p>
	<p>2A. W90153 (for 1<sup>1</sup>/<sub>2</sub>" return inlet)</p> <p>2B. W90155 (for 2" return inlet)</p>	<p><b>Retrofit Eyeball Return Line Diverter</b> Use to replace standard directional inlet eyeballs</p>
	<p>3. W26705</p>	<p><b>The Leaf Catcher with 4<sup>1</sup>/<sub>2</sub>" Hose Connector</b> Use when heavy debris or leaf situations exist.</p>
	<p>3. W46155</p>	<p><b>Large Wheel Deflector</b> Use when extra clearance is needed at steps or other obstacles.</p>

**ZODIAC POOL CARE, INC.**

2028 N.W. 25th Avenue  
 Pompano Beach, FL 33069  
 1-888-786-7797  
 www.zodiacpoolcare.com

# BETA® CARE AND MAINTENANCE

To maintain quality, performance and increase the lifespan of your Beta, please do the following:

1. Thoroughly clean the skimmer basket, pump basket and pool filter on a regular basis. **Always disconnect the hose from the skimmer before backwashing.**
2. **REMOVE THE CLEANER BEFORE SUPER CHLORINATING OR ADDING POOL CHEMICALS.** Reinstall the Beta when the imbalance is corrected or after a minimum of 4 hours from super chlorination. Chemical damage is not covered under warranty.
3. **NEVER COIL THE HOSE** when the cleaner is removed from the pool. A coiled hose can be straightened with hot water or by laying it on a warm pool deck for several hours.

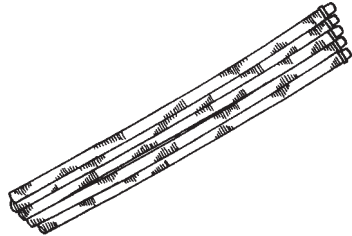

**CORRECT**

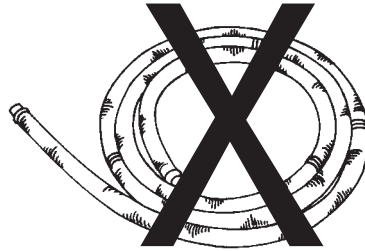

**INCORRECT**

4. Remove disc and store it flat during the off-season. Store the cleaner head in a warm and dry place.

## Easy Access System

Foreign objects, such as children's toys, tree branches and rocks, should be removed manually from your pool prior to operating your Beta. If a blockage should occur, the Easy Access System will allow you to check the diaphragm for damage and remove the blockage in minutes at poolside.

### DIAPHRAGM REMOVAL

Remove the wheel deflector (Figure 1). Loosen the handnut by turning it counter clockwise one full turn (Figure 2). (Do not loosen or remove the handnut completely.) Turn the unit over, grasp the diaphragm by the flange (Figure 3) and pull the diaphragm/ assembly out of the body (Figure 4). Remove the diaphragm from the inner extension pipe (Figure 5), leaving the retaining ring on the diaphragm and inspect for blockage or cuts. Remove blockage and rinse. Do not use sharp objects as damage to diaphragm may occur. If replacement parts are needed, contact technical service at 1-888-786-7797 for an authorized warranty station.

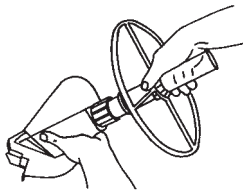

**Step 1**

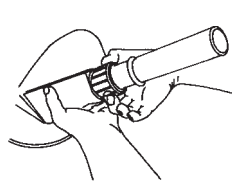

**Step 2**

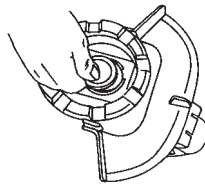

**Step 3**

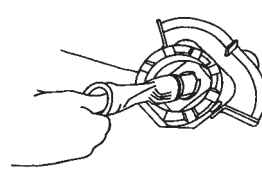

**Step 4**

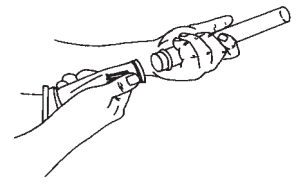

**Step 5**

### DIAPHRAGM ASSEMBLY

Prior to reinstalling the diaphragm, rinse the diaphragm and the inner extension pipe thoroughly to remove any grit or algae. Attach the diaphragm to the inner extension pipe using the retaining ring (Figure 6). Slide the top of the inner extension pipe (the end which is opposite the diaphragm) into the body (Figure 7). Pressing on the underside of the diaphragm's ridges (Figure 8), push the diaphragm into the body, aligning the flange with the accommodating slot (Figure 9). The diaphragm should fit flush against the inlet plate. Tighten the handnut turning it clockwise. Do not overtighten.

To check that the assembly has been done properly, turn the unit upside down, grip the outer extension pipe and spin the body (Figure 10). If it does not spin freely, loosen the handnut, spin outer extension pipe and retighten the handnut. Finally, reinstall the wheel deflector.

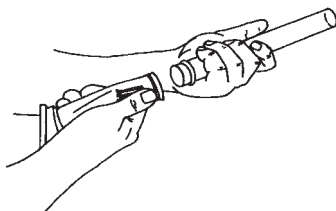

**Step 6**

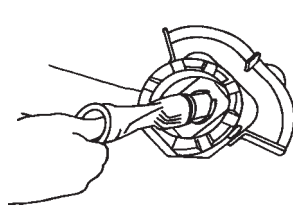

**Step 7**

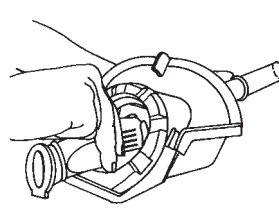

**Step 8**

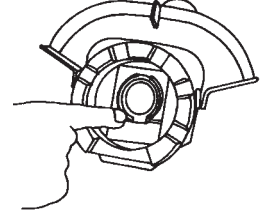

**Step 9**

# BETA® PARTS DIAGRAM

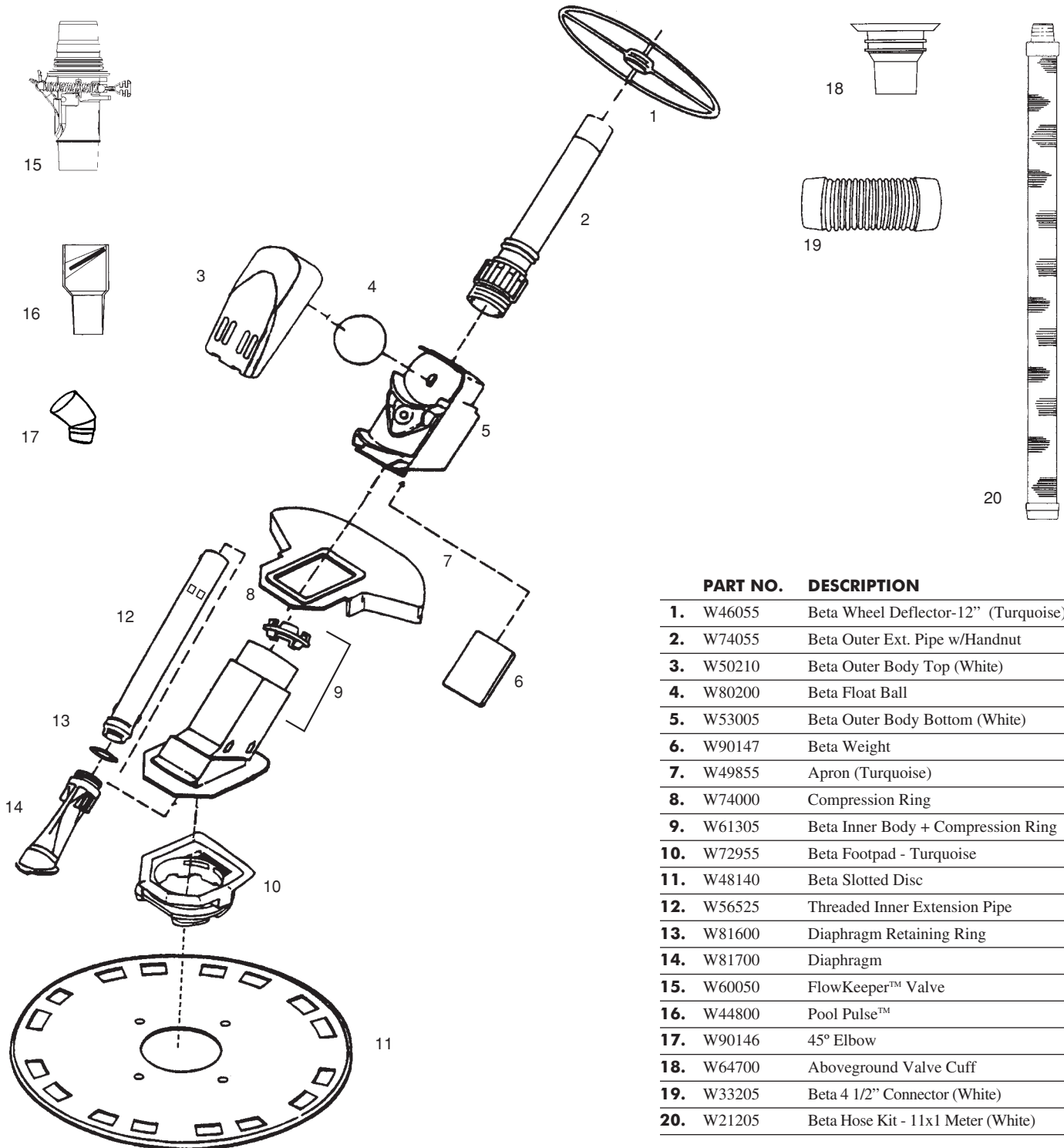

PART NO.	DESCRIPTION	QTY.
1.	W46055 Beta Wheel Deflector-12'' (Turquoise)	1
2.	W74055 Beta Outer Ext. Pipe w/Handnut	1
3.	W50210 Beta Outer Body Top (White)	1
4.	W80200 Beta Float Ball	1
5.	W53005 Beta Outer Body Bottom (White)	1
6.	W90147 Beta Weight	1
7.	W49855 Apron (Turquoise)	1
8.	W74000 Compression Ring	1
9.	W61305 Beta Inner Body + Compression Ring	1
10.	W72955 Beta Footpad - Turquoise	1
11.	W48140 Beta Slotted Disc	1
12.	W56525 Threaded Inner Extension Pipe	1
13.	W81600 Diaphragm Retaining Ring	1
14.	W81700 Diaphragm	1
15.	W60050 FlowKeeper™ Valve	1
16.	W44800 Pool Pulse™	1
17.	W90146 45° Elbow	1
18.	W64700 Aboveground Valve Cuff	1
19.	W33205 Beta 4 1/2'' Connector (White)	1
20.	W21205 Beta Hose Kit - 11x1 Meter (White)	1

## ZODIAC POOL CARE, INC.

2028 N.W. 25th Avenue  
Pompano Beach, FL 33069

1-888-786-7797

www.zodiacpoolcare.com